

Auto-reset  
(if using CP2104)

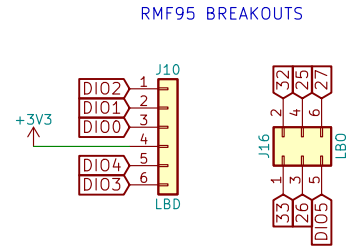

Programming

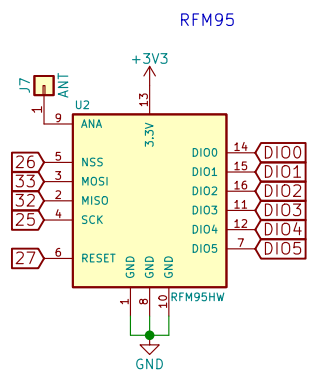
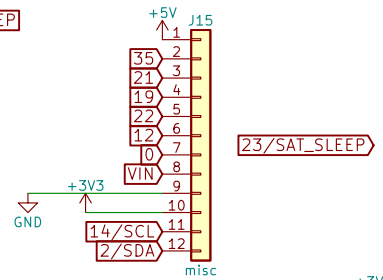
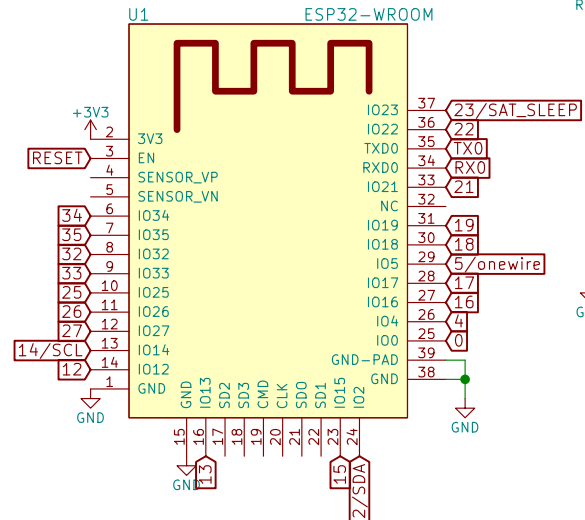
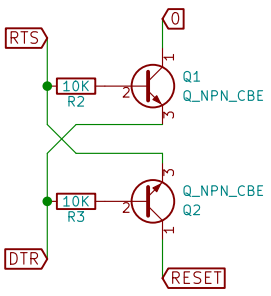
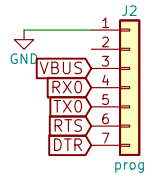

SD Card

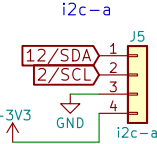
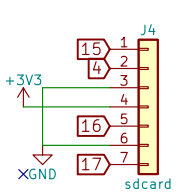

1-wire

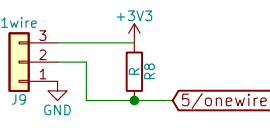

DHT22

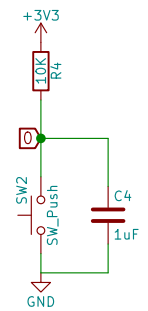
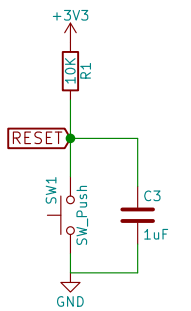
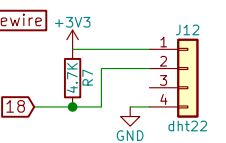

i2c pullups

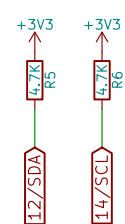

i2c-screwterm

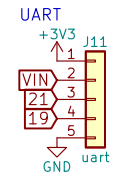

Sheet: /		Date:	
File: hog32.sch		Rev:	
Size: A4	KiCad E.D.A. kicad 5.1.6-c6e7f7d87ubuntu18.04.1		Id: 1/1